

CENTRAL MACHINERY[®]

2HP DUST COLLECTOR

Model 97869

SET UP AND OPERATING INSTRUCTIONS



Diagrams within this manual may not be drawn proportionally.

Due to continuing improvements, actual product may differ slightly from the product described herein.

Distributed exclusively by Harbor Freight Tools[®].

3491 Mission Oaks Blvd., Camarillo, CA 93011

Visit our website at: <http://www.harborfreight.com>



**Read this material before using this product.
Failure to do so can result in serious injury.
SAVE THIS MANUAL.**

Copyright[©] 2008 by Harbor Freight Tools[®]. All rights reserved. No portion of this manual or any artwork contained herein may be reproduced in any shape or form without the express written consent of Harbor Freight Tools.

For technical questions or replacement parts, please call 1-800-444-3353.

CONTENTS

LIMITED 1 YEAR / 90 DAY
WARRANTY 16

IMPORTANT SAFETY INFORMATION	3
GENERAL SAFETY RULES	3
PERSONAL SAFETY	4
SPECIFIC SAFETY RULES	5
GROUNDING	6
GROUNDING TOOLS: TOOLS WITH THREE PRONG PLUGS	6
DOUBLE INSULATED TOOLS: TOOLS WITH TWO PRONG PLUGS	6
EXTENSION CORDS	7
SYMBOLS	7
SPECIFICATIONS.....	8
FEATURES	8
UNPACKING	8
LIST OF CONTENTS.....	8
INITIAL SET UP INSTRUCTIONS .	8
ASSEMBLY	8
OPERATING INSTRUCTIONS	11
TOOL SET UP	11
WORK PIECE AND WORK AREA SET UP	11
GENERAL OPERATING INSTRUCTIONS	11
CLEANING AND MAINTENANCE ...	12
TROUBLESHOOTING.....	13
PARTS LIST	14
ASSEMBLY DIAGRAM.....	15

SAVE THIS MANUAL

Keep this manual for the safety warnings and precautions, assembly, operating, inspection, maintenance and cleaning procedures. Write the product's serial number in the back of the manual near the assembly diagram (or month and year of purchase if product has no number). Keep this manual and the receipt in a safe and dry place for future reference.

IMPORTANT SAFETY INFORMATION

In this manual, on the labeling, and all other information provided with this product:



This is the safety alert symbol. It is used to alert you to potential personal injury hazards. Obey all safety messages that follow this symbol to avoid possible injury or death.

DANGER

DANGER indicates a hazardous situation which, if not avoided, will result in death or serious injury.

WARNING

WARNING indicates a hazardous situation which, if not avoided, could result in death or serious injury.

CAUTION

CAUTION, used with the safety alert symbol, indicates a hazardous situation which, if not avoided, could result in minor or moderate injury.

NOTICE

NOTICE is used to address practices not related to personal injury.

CAUTION

CAUTION, without the safety alert symbol, is used to address practices not related to personal injury.

General Safety Rules



WARNING! Read all instructions. Failure to follow all instructions listed below may result in electric shock, fire, and/or serious injury. The term "power tool" in all of the warnings listed below refers to your line-operated (corded) power tool or battery-operated (cordless) power tool.



SAVE THESE INSTRUCTIONS

1. **Work area safety**
 - a. Keep work area clean and well lit. *Cluttered or dark areas invite accidents.*
 - b. Do not operate power tools in explosive atmospheres, such as in the presence of flammable liquids, gases or dust. *Power tools create sparks which may ignite the dust or fumes.*
 - c. **Keep children and bystanders away while operating power tools.**
2. **Electrical safety**
 - a. Power tool plugs must match the outlet. Never modify the plug in any way. Do not use any adapter plugs with grounded power tools. *Unmodified plugs and matching*

outlets will reduce risk of electric shock.

- b. Avoid body contact with grounded surfaces such as pipes, radiators, ranges and refrigerators. *There is an increased risk of electric shock if your body is grounded.*
- c. **Do not expose power tools to rain or wet conditions. Water entering a power tool will increase the risk of electric shock.**
- d. **Do not abuse the cord. Never use the cord for carrying, pulling or unplugging the power tool. Keep cord away from heat, oil, sharp edges or moving parts. Damaged or entangled cords increase the risk of electric shock.**
- e. When operating a power tool outdoors, use an extension cord suitable for outdoor use. *Use of a cord suitable for outdoor use reduces the risk of electric shock.*

Personal safety

⚠️ WARNING

This product contains or, when used, produces a chemical known to the State of California to cause cancer and birth defects or other reproductive harm. (California Health & Safety Code 25249.5, et seq.)

- a. Stay alert, watch what you are doing and use common sense when operating a power tool. Do not use a power tool while you are tired or under the influence of drugs, alcohol or medication. *A moment of inattention while operating power tools may result in serious personal injury.*
- b. **Use safety equipment. Always wear eye protection. Safety**

equipment such as dust mask, non-skid safety shoes, hard hat, or hearing protection used for appropriate conditions will reduce personal injuries.

- c. Avoid accidental starting. Ensure the switch is in the off-position before plugging in. *Carrying power tools with your finger on the switch or plugging in power tools that have the switch on invites accidents.*
 - d. Do not overreach. Keep proper footing and balance at all times. *This enables better control of the power tool in unexpected situations.*
 - e. Dress properly. Do not wear loose clothing or jewelry. Keep your hair, clothing and gloves away from moving parts. *Loose clothes, jewelry or long hair can be caught in moving parts.*
 - f. Ensure this Dust Collector is connected and properly used. *Use of this Dust Collector can reduce dust-related hazards.*
 - g. **Avoid electrical shock.** Prevent body contact with grounded surfaces such as pipes, radiators, ranges, and cabinet enclosures when testing voltages. Do not tamper with grounded plug.
4. **Power tool use and care**
- a. Do not force the power tool. Use the correct power tool for your application. *The correct power tool will do the job better and safer at the rate for which it was designed.*
 - b. Do not use the power tool if the switch does not turn it on and off. *Any power tool that cannot be controlled with the switch is dangerous and must be repaired.*

- c. **Disconnect the plug from the power source and/or the battery pack from the power tool before making any adjustments, changing accessories, or storing power tools. *Such preventive safety measures reduce the risk of starting the power tool accidentally.***
- d. **Store idle power tools out of the reach of children and do not allow persons unfamiliar with the power tool or these instructions to operate the power tool. *Power tools are dangerous in the hands of untrained users.***
- e. Maintain power tools. Check for misalignment or binding of moving parts, breakage of parts and any other condition that may affect the power tool's operation. If damaged, have the power tool repaired before use. *Many accidents are caused by poorly maintained power tools.*
- f. **Use the right Dust Collector for the job.** Do not attempt to force a small Dust Collector to do the work of a larger industrial model. There are certain applications for which this Dust Collector was designed. Do not modify this Dust Collector and do not use this Dust Collector for a purpose for which it was not intended, taking into account the working conditions and the work to be performed. *Use of the power tool for operations different from those intended could result in a hazardous situation.*

5. Service

- a. Have your power tool serviced by a qualified repair person using only identical replacement parts. *This will ensure that the safety of the power tool is maintained.*

Specific Safety Rules

1. Maintain labels and nameplates on the tool. These carry important safety information. If unreadable or missing, contact Harbor Freight Tools for a replacement.
2. Avoid unintentional starting. Ensure the switch is in the "OFF" position before plugging the tool in. Prepare to begin work before turning on the tool.
3. Do not lay the hose-end down until it has come to a complete stop. The vacuum may pull in something you need.
4. Do not leave the tool unattended when it is plugged into an electrical outlet. Turn off the tool, and unplug it from its electrical outlet before leaving.
5. This product is not a toy. Keep it out of reach of children.
6. People with pacemakers should consult their physician(s) before use. Electromagnetic fields in close proximity to heart pacemaker could cause pacemaker interference or pacemaker failure. In addition, people with pacemakers should:
 - Avoid operating alone.
 - Properly maintain and inspect to avoid electrical shock.
 - Any power cord must be properly grounded. Ground Fault Circuit Interrupter (GFCI) should also be implemented – it prevents sustained electrical shock.



SAVE THESE INSTRUCTIONS.

GROUNDING

⚠️ WARNING TO PREVENT ELECTRIC SHOCK



AND DEATH FROM INCORRECT GROUNDING WIRE CONNECTION:

Check with a qualified electrician if you are in doubt as to whether the outlet is properly grounded. Do not modify the power cord plug provided with the tool. Never remove the grounding prong from the plug. Do not use the tool if the power cord or plug is damaged. If damaged, have it repaired by a service facility before use. If the plug will not fit the outlet, have a proper outlet installed by a qualified electrician.

Grounded Tools: Tools with Three Prong Plugs

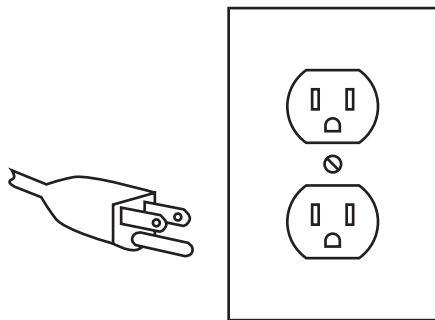

3-Prong Plug and Outlet

1. Tools marked with “Grounding Required” have a three wire cord and three prong grounding plug. The plug must be connected to a properly grounded outlet. If the tool should electrically malfunction or break down, grounding provides a low resistance path to carry electricity away from the user, reducing the risk

of electric shock. (See **3-Prong Plug and Outlet.**)

2. The grounding prong in the plug is connected through the green wire inside the cord to the grounding system in the tool. The green wire in the cord must be the only wire connected to the tool’s grounding system and must never be attached to an electrically “live” terminal. (See **3-Prong Plug and Outlet.**)
3. The tool must be plugged into an appropriate outlet, properly installed and grounded in accordance with all codes and ordinances. The plug and outlet should look like those in the preceding illustration. (See **3-Prong Plug and Outlet.**)
4. **Grounding the Dust Collector hose.** The extraction system of Dust Collectors, this includes pipes and hose, must be grounded to ensure there is no explosion.

Double Insulated Tools: Tools with Two Prong Plugs

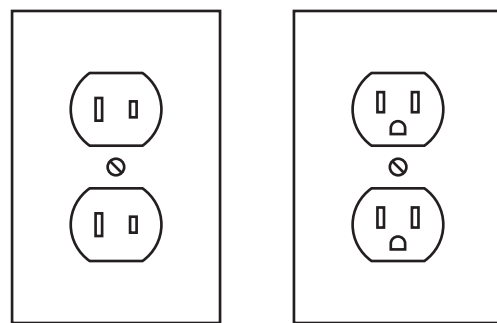

Outlets for 2-Prong Plug

1. Tools marked “Double Insulated” do not require grounding. They have a special double insulation system which satisfies OSHA requirements and complies with the applicable standards of Underwriters

Laboratories, Inc., the Canadian Standard Association, and the National Electrical Code. **(See Outlets for 2-Prong Plug.)**

2. Double insulated tools may be used in either of the 120 volt outlets shown in the preceding illustration. **(See Outlets for 2-Prong Plug.)**

Extension Cords

1. ***Grounded*** tools require a three wire extension cord. ***Double Insulated*** tools can use either a two or three wire extension cord.
2. As the distance from the supply outlet increases, you must use a heavier gauge extension cord. Using extension cords with inadequately sized wire causes a serious drop in voltage, resulting in loss of power and possible tool damage. **(See Table A.)** The smaller the gauge number of the wire, the greater the capacity of the cord. For example, a 14 gauge cord can carry a higher current than a 16 gauge cord. **(See Table A.)**
3. When using more than one extension cord to make up the total length, make sure each cord contains at least the minimum wire size required. **(See Table A.)**
4. If you are using one extension cord for more than one tool, add the nameplate amperes and use the sum to determine the required minimum cord size. **(See Table A.)**
5. If you are using an extension cord outdoors, make sure it is marked with the suffix "W-A" ("W" in Canada) to





indicate it is acceptable for outdoor use.

6. Make sure the extension cord is properly wired and in good electrical condition. Always replace a damaged extension cord or have it repaired by a qualified electrician before using it.
7. Protect the extension cords from sharp objects, excessive heat, and damp or wet areas.

RECOMMENDED MINIMUM WIRE GAUGE FOR EXTENSION CORDS* (120/240 VOLT)					
NAMEPLATE AMPERES (at full load)	EXTENSION CORD LENGTH				
	25'	50'	75'	100'	150'
0 – 2.0	18	18	18	18	16
2.1 – 3.4	18	18	18	16	14
3.5 – 5.0	18	18	16	14	12
5.1 – 7.0	18	16	14	12	12
7.1 – 12.0	18	14	12	10	-
12.1 – 16.0	14	12	10	-	-
16.1 – 20.0	12	10	-	-	-

TABLE A * Based on limiting the line voltage drop to five volts at 150% of the rated amperes.

Symbology

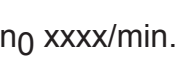
	Double Insulated
	Canadian Standards Association
	Underwriters Laboratories, Inc.
	Volts Alternating Current
	Amperes
	No Load Revolutions per Minute (RPM)

SPECIFICATIONS

Motor	120 Volts, 60 Hz, 2HP, Single Phase, 20 AMPS Peak,
RPM	3450
Bag Dimensions	Top=19-1/2" Dia. x 30"L Bottom=19-1/2" Dia. x 30-7/8"L
Bag Filtration Ratio	5 Microns
Intake	4-3/8" ID (screen & filter)
Exhaust Diameter	4-1/2 Inch ID With Screen

FEATURES

1	All ball-bearing balanced armature
2	Aluminum and plastic locking casters
3	Cast Iron Motor Housing
4	Lockable toggle switch
5	Fan cooled

UNPACKING

When unpacking, check to make sure that the item is intact and undamaged. If any parts are missing or broken, please call Harbor Freight Tools at the number shown on the cover of this manual as soon as possible.

List of contents

Part	Description	Q'ty
1	Collection Bags	2
2	Swivel Casters (locking)	4
3	Hex Wrenches	2

INITIAL SET UP INSTRUCTIONS



Read the **ENTIRE IMPORTANT SAFETY INFORMATION** section at the beginning of this manual including all text under

subheadings therein before set up or use of this product.

⚠ WARNING TO PREVENT SERIOUS INJURY FROM ACCIDENTAL OPERATION:
Turn the Power Switch of the tool to its "OFF" position and unplug the tool from its electrical outlet before assembling or making any adjustments to the tool.

Note: For additional information regarding the parts listed in the following pages, refer to the Assembly Diagram near the end of this manual.

ASSEMBLY

1. Your Dust Collector will require complete assembly prior to use. It is important that you read the entire manual to become familiar with the product BEFORE you use the Dust Collector. Before assembling the Dust Collector be sure that you have all parts described in the Parts List and Assembly Diagram.
 - a. Step 1) Place Caster (see Parts List 1) in place on the underside corner of the Base Plate (3). For all four (4) corners of the Caster (1) insert one Hex Screw (23) through Washer (16) down into Base Plate (3) and through Caster (1). Thread on Nut (19). Repeat for the remaining three (3) Casters (#1).

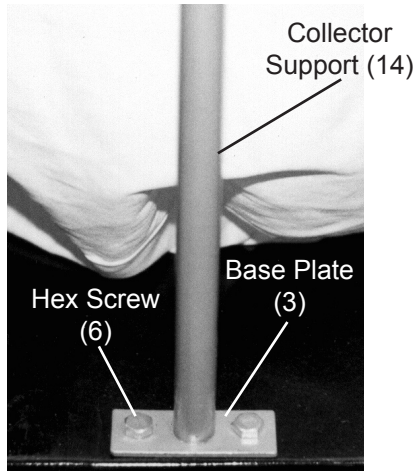

Figure 1

- b. Step 2) Attach the first Collector Support (14) to the Base Plate (3). Line up the Collector Support (14) with holes on edge of the Base Plate (3). Insert Hex Bolt (6) down through Washer (4), Base Plate (3) and secure in place with Nut (2). (See Figure 1.)

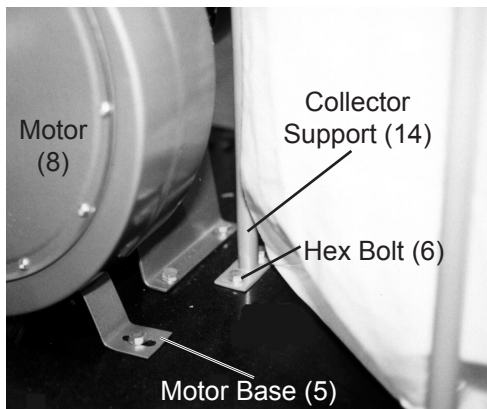

Figure 2

- c. Step 3) Attach the second Collector Support (14) through the inside holes near where the Motor Base (5) will be mounted. (See Figure 2.) Insert Hex Bolt (6) down through Washer (4) and Base Plate (3) and secure in place with Nut (2). (See Figure 2.)



Figure 3

- d. Step 4) The Fan Housing (38) is attached to the Motor (8) and Motor Base (5) as a single unit. Secure the Motor Base (5) to the Base Plate (3) using six (6) Hex Bolts (6), six (6) Washers (4) and six Nuts (2). (See Figures 2 and 3.)

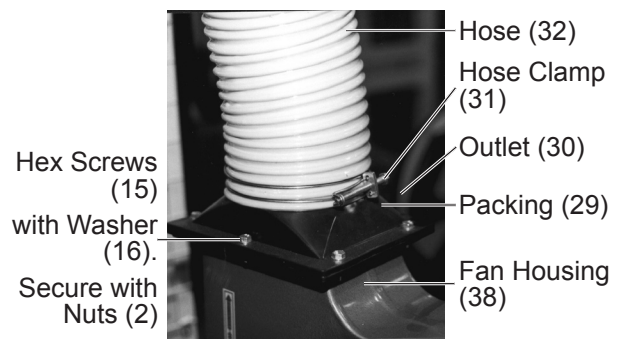

Figure 4

- e. Step 5) Set the Packing (29) on top of the rectangular opening on the Fan Housing (38) (see Step 4). Set the Outlet (30) on top of the Fan Housing (38) and Packing (29)-see Figure 4. Slide Washer (16) onto Hex Screws (15) and thread into the six (6) holes in the lip of Outlet (30), Fan Housing (38) and Packing (29). Secure in place with Nuts (2). (See Figure 4.)

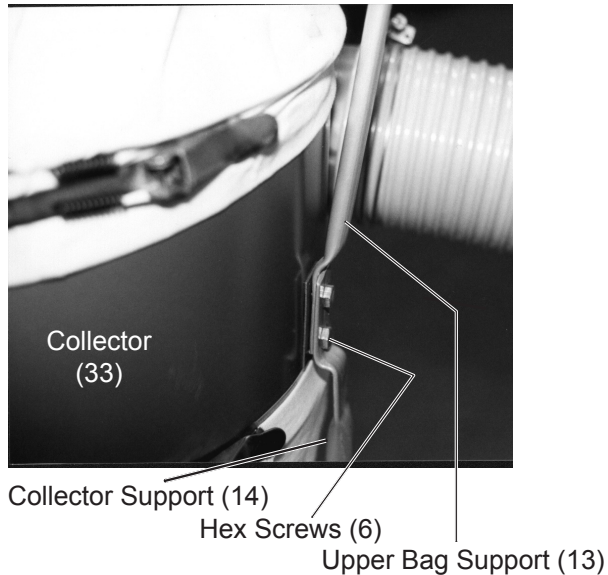

Figure 5

to lock in place. Extend the bag so that the loop on the top hangs on the Upper Bag Support (13).

- j. Step 10) Place the Collection Bag (36) on the bottom of the Collector (33) and secure it with a clamp as in step 9.

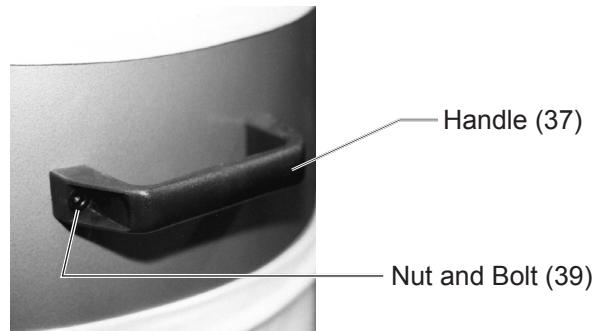

Figure 6

- f. Step 6) Connect the Upper Bag Support (13) to the Collector Support (14) and Collector (33). Thread in both Hex Screws (6) through the Collector Support (14) and through the Upper Bag Support (13) and into the Collector (33). (See Figure 5.)
- g. Step 7) Slide the Hose Clamp (31) onto the Hose (32). Slide Hose (32) with Hose Clamp (31) onto the Outlet (30). Once the Hose (32) is in place, tighten the screw on the Hose Clamp (31) until the Hose (32) is securely fastened to the Outlet (30). (See Figure 4.)
- h. Step 8) Slide the Hose Clamp (31) onto the other end of the Hose (32). Slide the top opening of the Hose (32) over the duct in the Collector (33). Tighten the screw on the Hose Clamp (31) until the Hose (32) is securely fastened.
- i. Step 9) Place the Filter Bag (35) on top of the Collector (33). Once the Filter Bag is in place, adjust the clamp so that the clip rests between the teeth. Press the clamp down

- k. Step 11) Attach the Handle (37) to the Collector (33) with Nut and Bolt (39). (See Figure 6.)

OPERATING INSTRUCTIONS



Read the **ENTIRE IMPORTANT SAFETY INFORMATION** section at the beginning of this manual including all text under subheadings therein before set up or use of this product.

Tool Set Up



WARNING TO PREVENT SERIOUS INJURY

FROM ACCIDENTAL OPERATION:

Turn the Power Switch of the tool to its "OFF" position and unplug the tool from its electrical outlet before performing any inspection, maintenance, or cleaning procedures.

Work Piece and Work Area Set Up

1. Designate a work area that is clean and well lit. The work area must not allow access by children or pets to prevent injury and distraction.
2. Route the power cord along a safe route to reach the work area without creating a tripping hazard or exposing the power cord to possible damage. The power cord must reach the work area with enough extra length to allow free movement while working.
3. Secure loose workpieces using a vise or clamps (not included) to prevent movement while working.
4. There must not be hazardous objects such as utility lines or foreign objects, nearby that will present a hazard while working.

General Operating Instructions

This unit is designed for use with an existing dust system, or you can construct a new system.

1. If constructing a new system, connect 4" vent pipe (not included) to the 4" inlet side of the collector.
2. **4" Inlet (24)** Determine the size of the dust ports on your tools and run vacuum hoses (not included) from each tool to an appropriate sized adapter (not included), and into the 4" vent pipe (not included).



WARNING Do not tamper with or remove the

grounding pole on the plug. You must use this unit with a 3 pole receptacle. If you use an extension cord, it must meet amperage specified (16 AWG), and the cord must be 3-pronged.

3. Make sure the **Collection Bag (36)** is on tight and not leaking. Switch on the unit using the toggle **Switch (9)**.
4. During operation, periodically check how full the **Collection Bag (36)** is. Do not let it fill more than 3/4 full. A completely full bag puts a lot of stress on the bag and the belt.
5. To change **Collection Bag (36)**, wear ANSI-approved safety goggles, and a dust mask. Remove the **Belt (34)** and empty the bag. Reinstall the bag and belt.
6. To prevent accidents, turn off the tool and disconnect its power supply after use. Clean, then store the tool indoors out of children's reach.

Cleaning and Maintenance



.Procedures not specifically explained in this manual must be performed only by a qualified technician.

⚠️WARNING

TO PREVENT SERIOUS INJURY FROM ACCIDENTAL OPERATION:

Turn the Power Switch of the tool to its “OFF” position and unplug the tool from its electrical outlet before performing any inspection, maintenance, or cleaning procedures.

TO PREVENT SERIOUS INJURY FROM TOOL FAILURE:

Do not use damaged equipment. If abnormal noise or vibration occurs, have the problem corrected before further use.

1. Check the integrity of the 3-prong plug and cord. Make sure the grounding pole is not bent and the cord isn't torn or frayed.
2. Check your **Collection Bags (36)** prior to each use for tears or fraying. Replace if necessary.
3. Periodically tighten the **Belts (34)** and **Hose Clamps (31)**.
4. Keep the **Motor (8)** clean of dirt and debris
5. **BEFORE EACH USE**, inspect the general condition of the tool. Check for loose screws, misalignment or binding of moving parts, cracked or broken parts, damaged electrical

wiring, and any other condition that may affect its safe operation.

6. **AFTER USE**, clean external surfaces of the tool with clean cloth.

⚠️WARNING

If the supply cord of this power tool is damaged, it must be replaced only by a qualified service technician.

PLEASE READ THE FOLLOWING CAREFULLY

THE MANUFACTURER AND/OR DISTRIBUTOR HAS PROVIDED THE PARTS DIAGRAM IN THIS MANUAL AS A REFERENCE TOOL ONLY. NEITHER THE MANUFACTURER NOR DISTRIBUTOR MAKES ANY REPRESENTATION OR WARRANTY OF ANY KIND TO THE BUYER THAT HE OR SHE IS QUALIFIED TO MAKE ANY REPAIRS TO THE PRODUCT OR THAT HE OR SHE IS QUALIFIED TO REPLACE ANY PARTS OF THE PRODUCT. IN FACT, THE MANUFACTURER AND/OR DISTRIBUTOR EXPRESSLY STATES That ALL REPAIRS AND PARTS REPLACEMENTS SHOULD BE UNDERTAKEN BY CERTIFIED AND LICENSED TECHNICIANS AND NOT BY THE BUYER. THE BUYER ASSUMES ALL RISK AND LIABILITY ARISING OUT OF HIS OR HER REPAIRS TO THE ORIGINAL PRODUCT OR REPLACEMENT PARTS THERETO, OR ARISING OUT OF HIS OR HER INSTALLATION OF REPLACEMENT PARTS THERETO.

NOTE: Some parts are listed and shown for illustration purposes only and are not available individually as replacement parts.

Troubleshooting

Problem	Possible Causes	Likely Solutions
Tool will not start	1. No power at outlet. 2. Cord not connected.	1. Check power at outlet. 2. Check that cord is plugged in.
 Follow all safety precautions whenever diagnosing or servicing the tool. Disconnect power supply before service.		

PLEASE READ THE FOLLOWING CAREFULLY

THE MANUFACTURER AND/OR DISTRIBUTOR HAS PROVIDED THE PARTS LIST AND ASSEMBLY DIAGRAM IN THIS MANUAL AS A REFERENCE TOOL ONLY. NEITHER THE MANUFACTURER OR DISTRIBUTOR MAKES ANY REPRESENTATION OR WARRANTY OF ANY KIND TO THE BUYER THAT HE OR SHE IS QUALIFIED TO MAKE ANY REPAIRS TO THE PRODUCT, OR THAT HE OR SHE IS QUALIFIED TO REPLACE ANY PARTS OF THE PRODUCT. IN FACT, THE MANUFACTURER AND/OR DISTRIBUTOR EXPRESSLY STATES THAT ALL REPAIRS AND PARTS REPLACEMENTS SHOULD BE UNDERTAKEN BY CERTIFIED AND LICENSED TECHNICIANS, AND NOT BY THE BUYER. THE BUYER ASSUMES ALL RISK AND LIABILITY ARISING OUT OF HIS OR HER REPAIRS TO THE ORIGINAL PRODUCT OR REPLACEMENT PARTS THERETO, OR ARISING OUT OF HIS OR HER INSTALLATION OF REPLACEMENT PARTS THERETO.

PARTS LIST

Part	Description
1	Caster, 3" lockable
2	Nut M8-1.25
3	Base Plate
4	Washer M8
5	Motor Base
6	Hex Bolt M8-1.25x16
7	Power Cord
8	Motor 110V, 60Hz, 2HP
9	Switch
10	Screw
11	Hex Wrench 4mm
12	Hex Wrench 5mm
13	Upper Bag Support
14	Collector Support
15	Hex Screw M6-1.0x20mm
16	Washer M6
17	Key
18	Packing
19	Nut M6-1.0
20	Washer M10
21	Hex Screw M10-1.5x16
22	Turbo Fan
23	Hex Screw M6-1.0x10
24	Inlet
25	Inlet Cover
26	Hex Screw M6-1.0x20 LH
27	Washer
28	Hex Screw M8-1.25x8
29	Packing
30	Outlet
31	Hose Clamp
32	Hose
33	Collector
34	Belt
35	Filter Bag
36	Collection Bag
37	Handle
38	Fan Housing
39	Bolts & Nuts for Handle
40	Hex Wrench

ASSEMBLY DIAGRAM

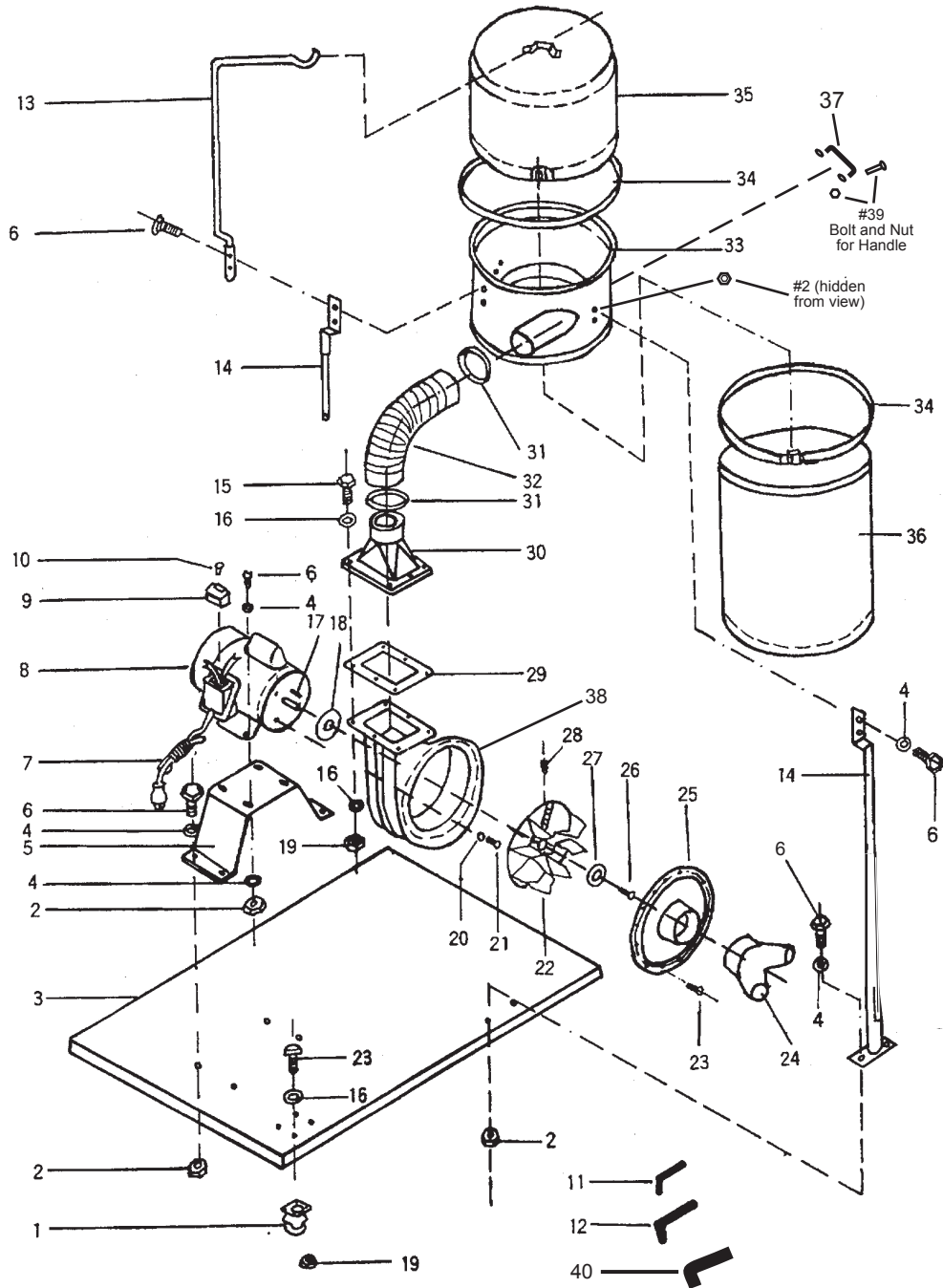

Record Product's Serial Number Here: _____

Note: If product has no serial number, record month and year of purchase instead.

Note: Some parts are listed and shown for illustration purposes only, and are not available individually as replacement parts.

LIMITED 1 YEAR / 90 DAY WARRANTY

Harbor Freight Tools Co. makes every effort to assure that its products meet high quality and durability standards, and warrants to the original purchaser that for a period of ninety days from date of purchase that the engine/motor, the belts (if so equipped), and the blades (if so equipped) are free of defects in materials and workmanship. Harbor Freight Tools also warrants to the original purchaser, for a period of one year from date of purchase, that all other parts and components of the product are free from defects in materials and workmanship (90 days if used by a professional contractor or if used as rental equipment). This warranty does not apply to damage due directly or indirectly, to misuse, abuse, negligence or accidents, repairs or alterations outside our facilities, normal wear and tear, or to lack of maintenance. We shall in no event be liable for death, injuries to persons or property, or for incidental, contingent, special or consequential damages arising from the use of our product. Some states do not allow the exclusion or limitation of incidental or consequential damages, so the above limitation of exclusion may not apply to you. THIS WARRANTY IS EXPRESSLY IN LIEU OF ALL OTHER WARRANTIES, EXPRESS OR IMPLIED, INCLUDING THE WARRANTIES OF MERCHANTABILITY AND FITNESS.

To take advantage of this warranty, the product or part must be returned to us with transportation charges prepaid. Proof of purchase date and an explanation of the complaint must accompany the merchandise. If our inspection verifies the defect, we will either repair or replace the product at our election or we may elect to refund the purchase price if we cannot readily and quickly provide you with a replacement. We will return repaired products at our expense, but if we determine there is no defect, or that the defect resulted from causes not within the scope of our warranty, then you must bear the cost of returning the product.

This warranty gives you specific legal rights and you may also have other rights which vary from state to state.

3491 Mission Oaks Blvd. • PO Box 6009 • Camarillo, CA 93011 • (800) 444-3353